

BEST SOLUTION
@ **ZHONGJI**

**WORLD STANDARD
COMPETITIVE COMPANY
ZHONGJI MACHINERY !!!**

Zhongji Machinery Was Founded In **1992**.
Polyurethane Sandwich Panel Production Line Made By Korea Hi-tech.
Factory Area Is 70,000 m² with More Than 600 Staffs And Ten Overseas Branch Offices.
CEO Of Zhongji, Mr Gunther Hou, Is The Vice President Of Chinese Private Enterprises Association.



 上海中吉机械有限公司
Shanghai Zhongji Machinery Co., Ltd.

ADD: 上海市嘉定区沪宜公路 5931 号 上海市青浦区新丹路 368 号
No.5931, Huiyi Road, Jiading Industry District, Shanghai, China
No.368, Xindan Road, Qingpu Industry District, Shanghai, China
TEL: +86-21-68453855 52303505 WHATSAPP: +86-13916868669
E-MAIL: info@zhongji.com WEBSITE: www.zhongji.com

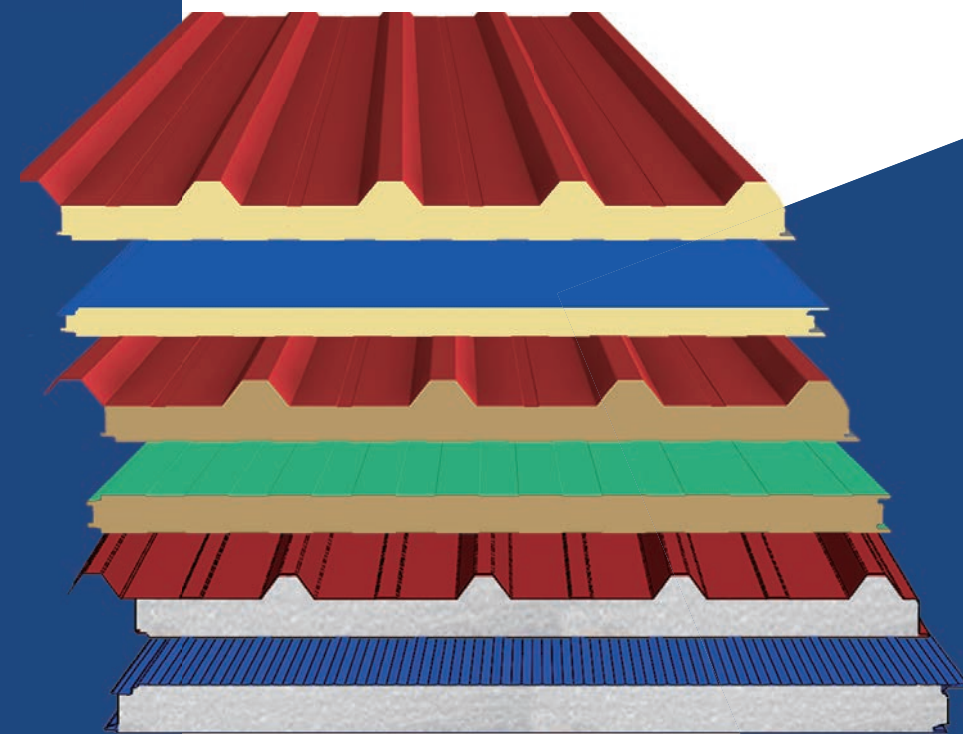

Чжунцзи Машиностроение
**MADE BY KOREAN
TECHNOLOGY AND DESIGNER**
ZHONGJI MACHINERY !!!

PU Sandwich Panel Production Line

Линия для производства сэндвич панели из полиуретана

MANUFACTURING PROCESS Процесс производства

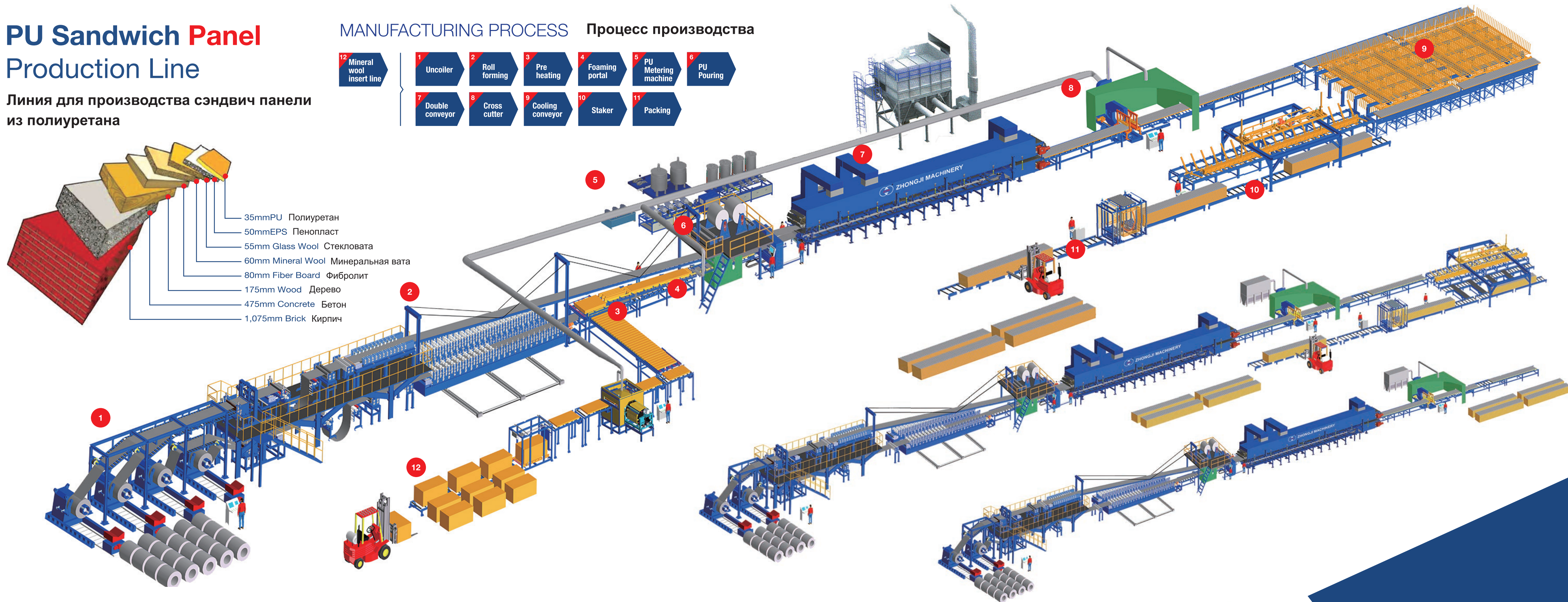
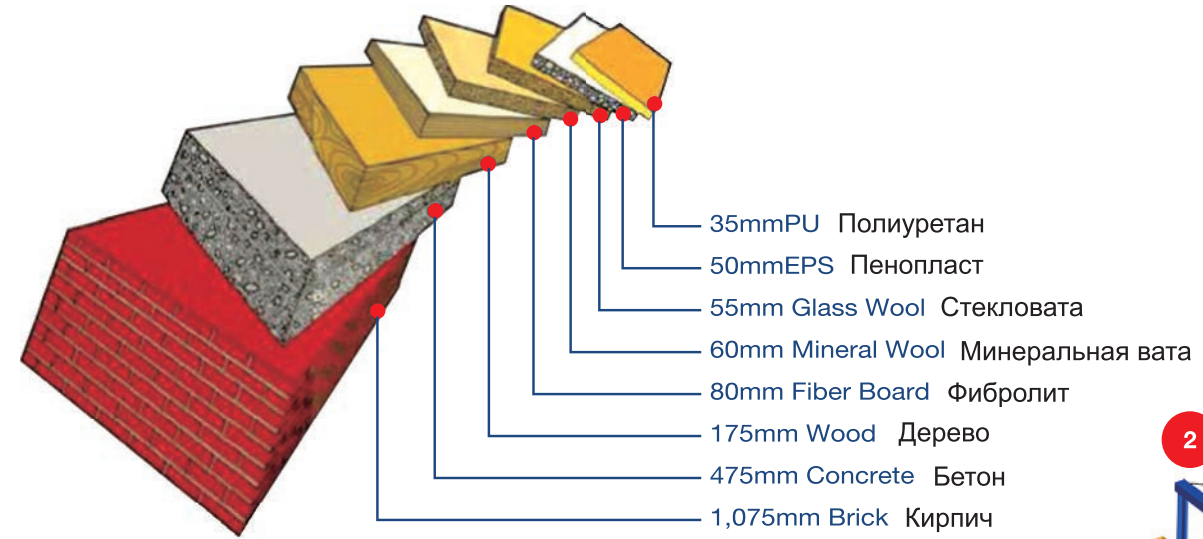
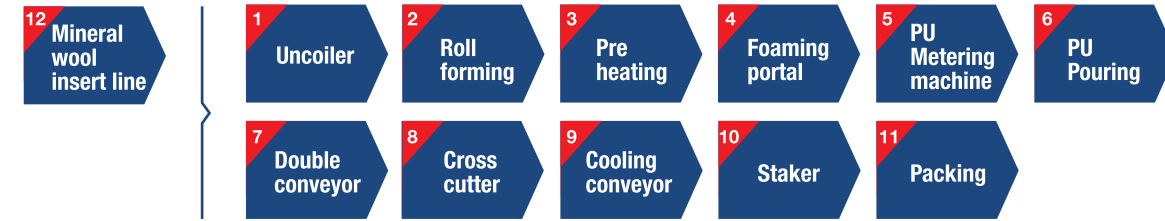

1 Uncoiler Разматыватель

Uncoiler for lower and upper facing. Uncoiler units including coil loader, pressing rollers, band edge control system, band delivery drivers, shearing, band connecting stations, looping station, delivery roller table.

Advantage: Time-saving (and therefore also cost-saving) continuous coil and band exchange standstill of the facility.



2 Roll Forming Профилегибочное оборудование

Roll Forming machines to shape surfaces and edges of the wall, roof and sectional door elements.

Advantage: Good accessibility and minimum profile exchange times by the serial installation of the profiling machines. Driving the profiling tool sets by means of DC motor including electronic control guarantees the synchronous inlet of the two metal widths into Double Conveyor facility without tension or thrust.



7 Double Slat Conveyor Гусеничный пресс



8 Side Block Боковые формы

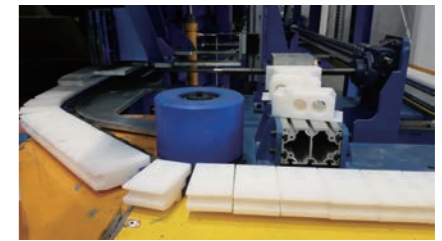

3 Pre Heating Подогревание



4 Potal & PU Foaming & Tank Station Заливание полиуретана

PU Foaming Machine Axial piston, series piston, single piston and diaphragm pumps to process the different components. Design of the entire "Wet part" complying with the environmental requirement.



5 Pentane metering machine Циклопентановая система



6 PU Pouring Заливание полиуретана

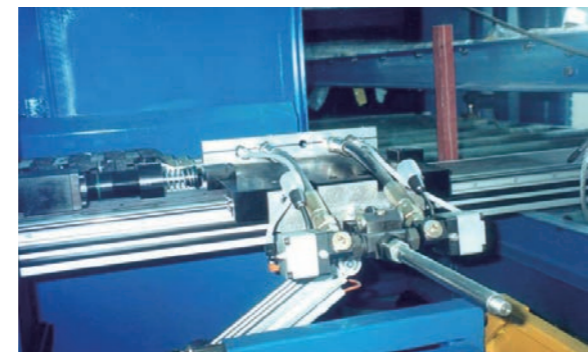

9 Heating System Система нагревания



10 Cross Cutter Ленточная резка

Cross Cutter to cut the continuous element hank to preprogrammed lengths. Belt saw for longitudinal saw and cut edge cleaning machine as well as sound insulation cabin, exhaust device and filtering installation.

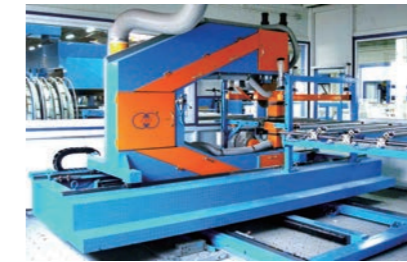

11 Cooling Conveyor and Stacker Охлаждение и штаблер

Crosshead design for separate stacking of 1A and 2A rated products.



12 Packing Упаковка



Mineral Wool (GlassWool) Sandwich Panel Production Line

Линия для производства сэндвич панели
из минваты/ базальта/ стекловаты

MANUFACTURING PROCESS

- 1 Transport Conveyor
- 2 Up-down Lift
- 3 Cutting & Cutting Saw
- 4 After Cutting
- 5 90 Rotatio
- 6 Double conveyor
- 7 Arrangement Conveyor

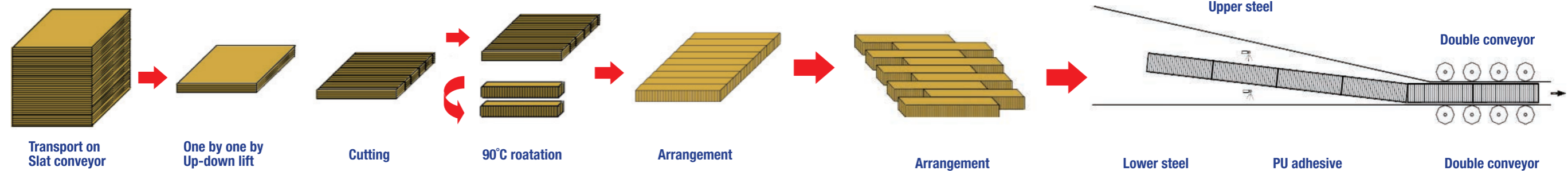
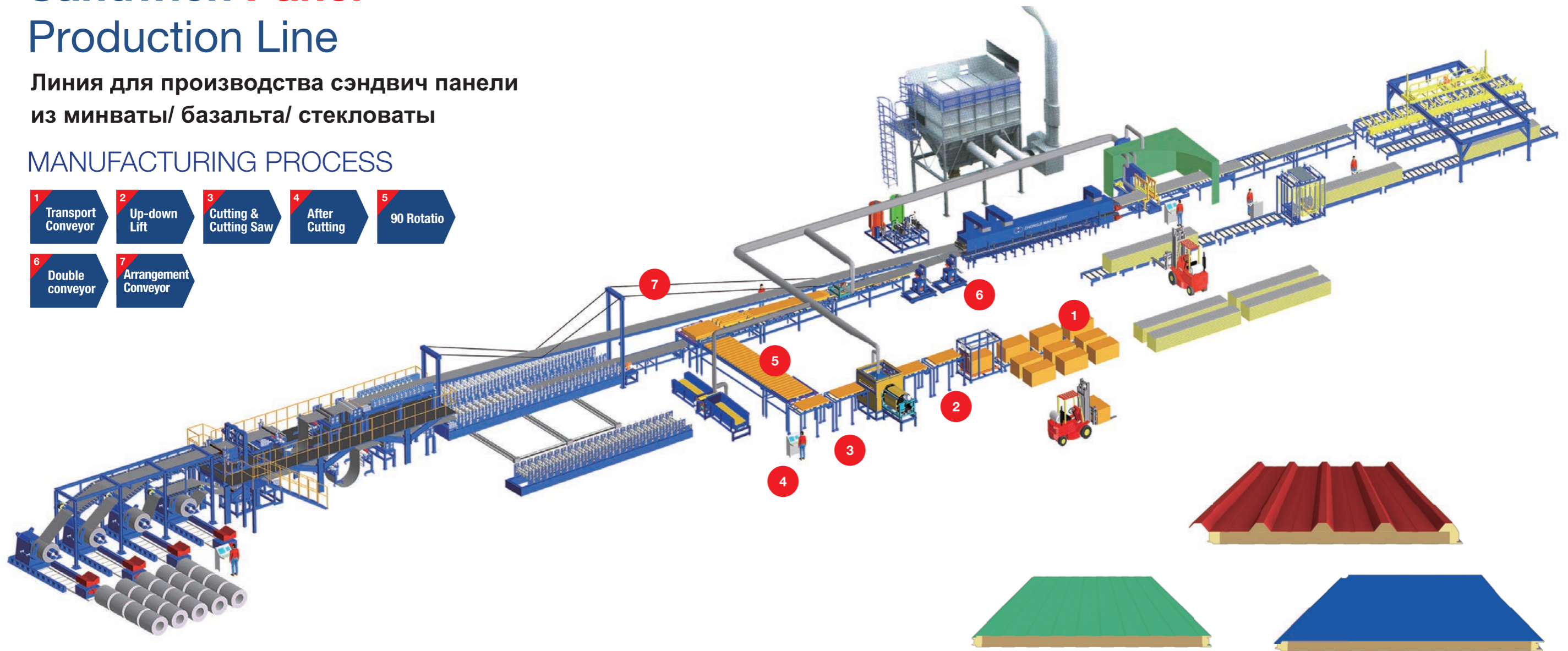

Mineral wool Board Supply, Cutting & Turning System

Автоматическая система для минваты резка & переворачивание

Consists of Transfer conveyor, Lift, Board Cutter and Turning Conveyor in accordance with the thickness of sandwich panel, and supplies it to the equipment continuously.

1 Transport Conveyor

Конвейер



2 Up Down Lift

Подъёма



3 Cutting & Cutting Saw

Нарезание

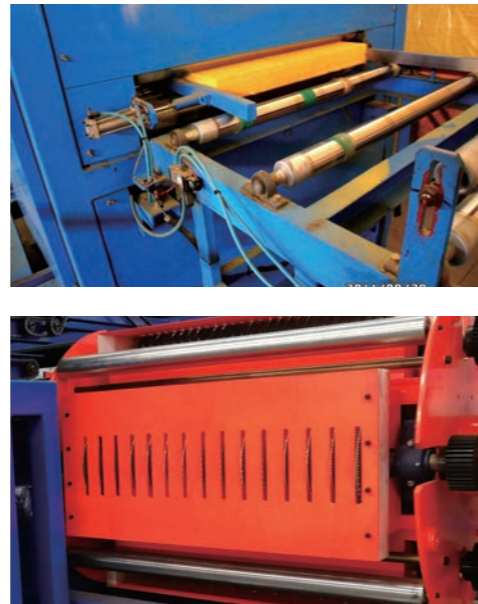

Board side trimming & supplying Подача нарезание переворачивание

Consists of Transfer conveyor, Lift, Board Cutter and Turning Conveyor in accordance with the thickness of sandwich panel, and supplies it to the equipment continuously.

4 After Cutting

После нарезания



5 90° Rotation

Переворачивание



6 Arrangement

Аранжировка



Mineral Wool Panel

Панель из минваты

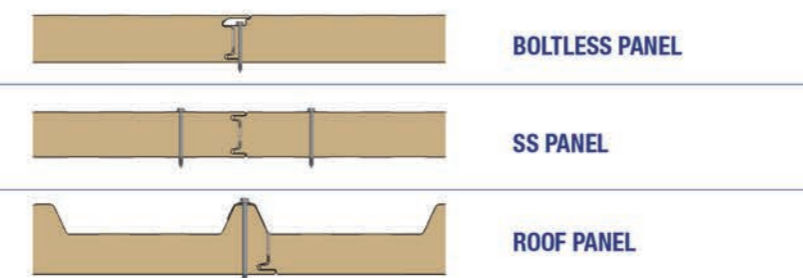

Glue applying system Система клея

It is a device applying glue, having a couple of types such as Mixing type and Spray type. Mixing type is widely used throughout the world, as it is relatively inexpensive and durable. Spray type can save the discharge and application quantity of glue, while the price is somewhat higher.

7 Arrangement Conveyor

Конвейер аранжировки



8 Pu bonding(Glue)

Клеивать клем



Insert to Double conveyor Заливание полиуретана

It is a device that makes the shape of sandwich panel applying constant pressure and heat to the upper and lower steel plates where glue is applied.

9 Insert to Double Conveyor

Заливание полиуретана

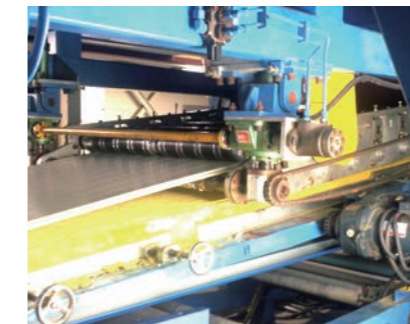

10 Pad Cutting

Резка панели



Mineral Wool + PU Panel

Панель из минваты с краем из полиуретна

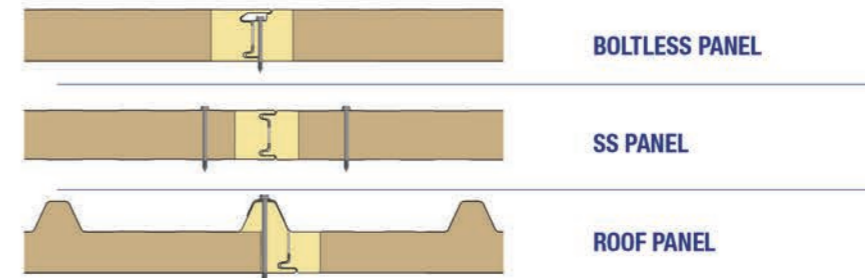

EPS/Mineral Wool Sandwich Panel Production Line (SP-10)

Линия для производства сэндвич панели
из пенопласта / минваты СП-10

MANUFACTURING PROCESS

- | | | | | | |
|--------------------|---------------------|----------------------------|---|-------------------------|--------------------------|
| 1
Uncoiler | 2
Grooving rolls | 3
Roll forming machines | 4
PU Bonding (Glue) | 5
Laminating Machine | |
| 6
Cutter | 7
Stacker | 8
Packing (Wrapping) | | | |
| A
Slat conveyor | B
Up-down lifter | C
Cutting machines | D
90 deg Turing & Arrangement conveyor | E
PU Bonding (Glue) | F
Pad cutting machine |

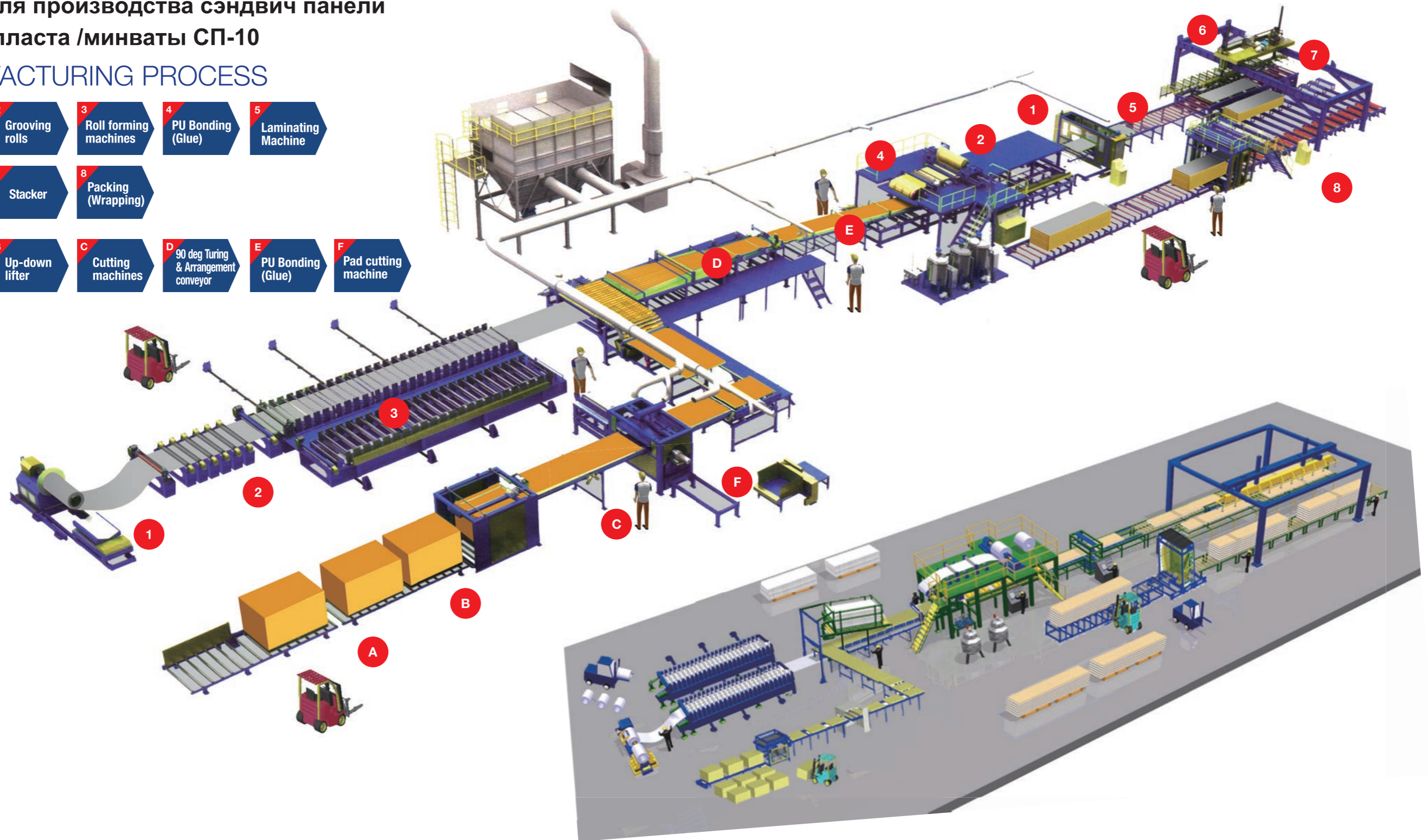

EPS/Rock Wool Sandwich Panel Production Line (SP-5/7/9)

Линия для производства сэндвич панели СП-5/ СП-7/ СП-9



SP9 ROOF PANEL

Крыша

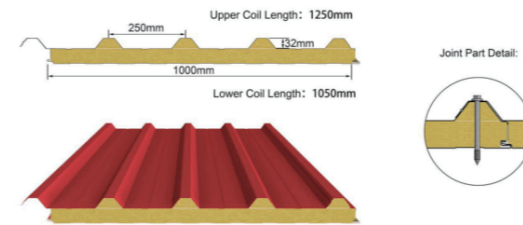

SP9 SS PANEL

Стена с замком Z-LOCK

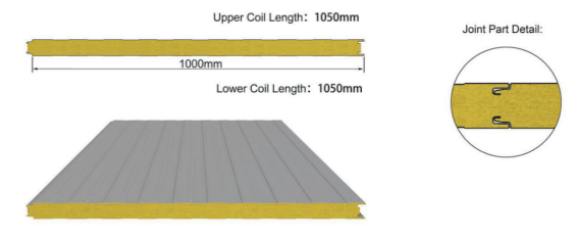

SP9 BOLTLESS PANEL

Стена с скрытым замком

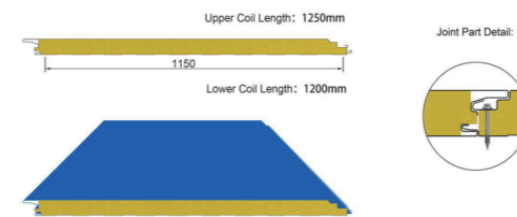

EPS PANEL

Панель из пенопласта

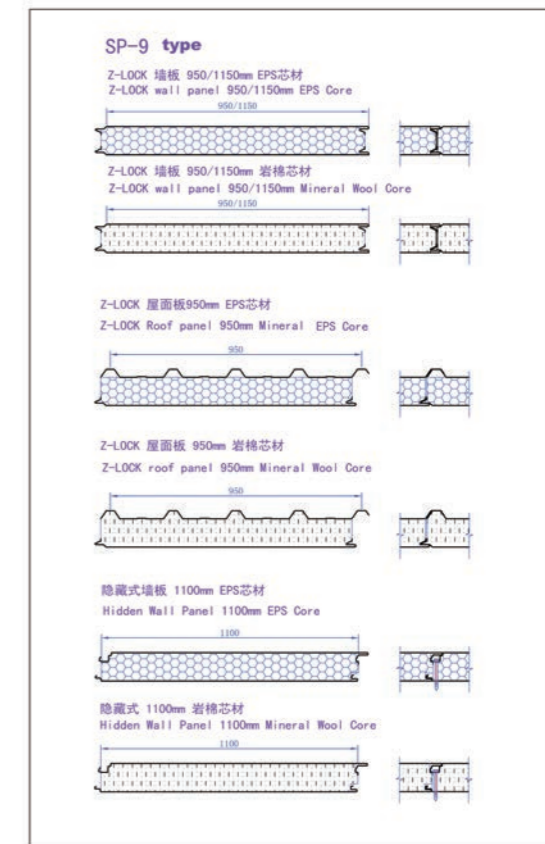
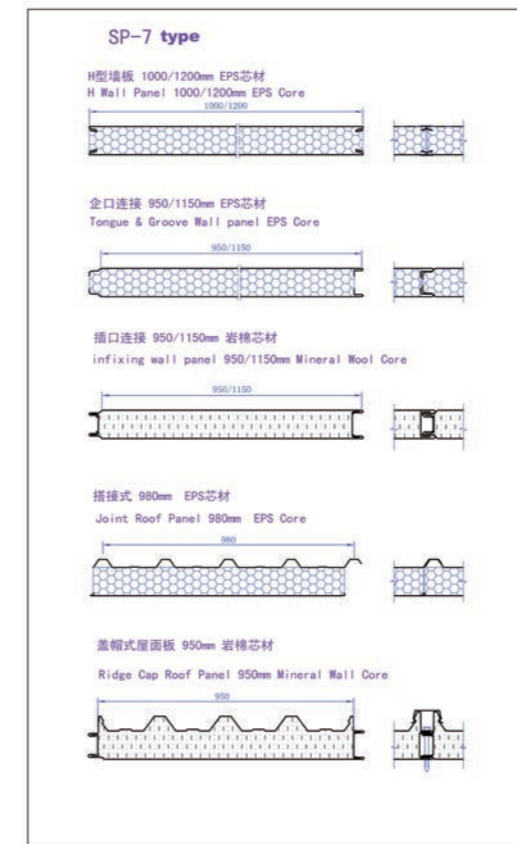
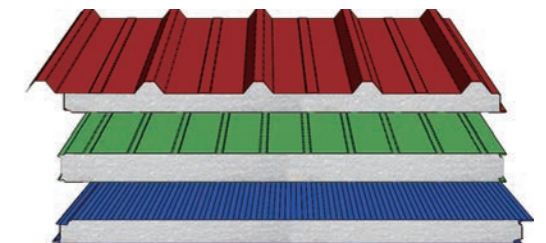

Flexible Facing PU/PIR/Phenolic/Board Panel Production Line (Insulation Board / Al Duct Panel)

Линия для производства сэндвич панели из ПИР/ПУР/фенолальдегида с мягкой поверхности (Декоративный панель /Алюминиевый трубчатый панель)

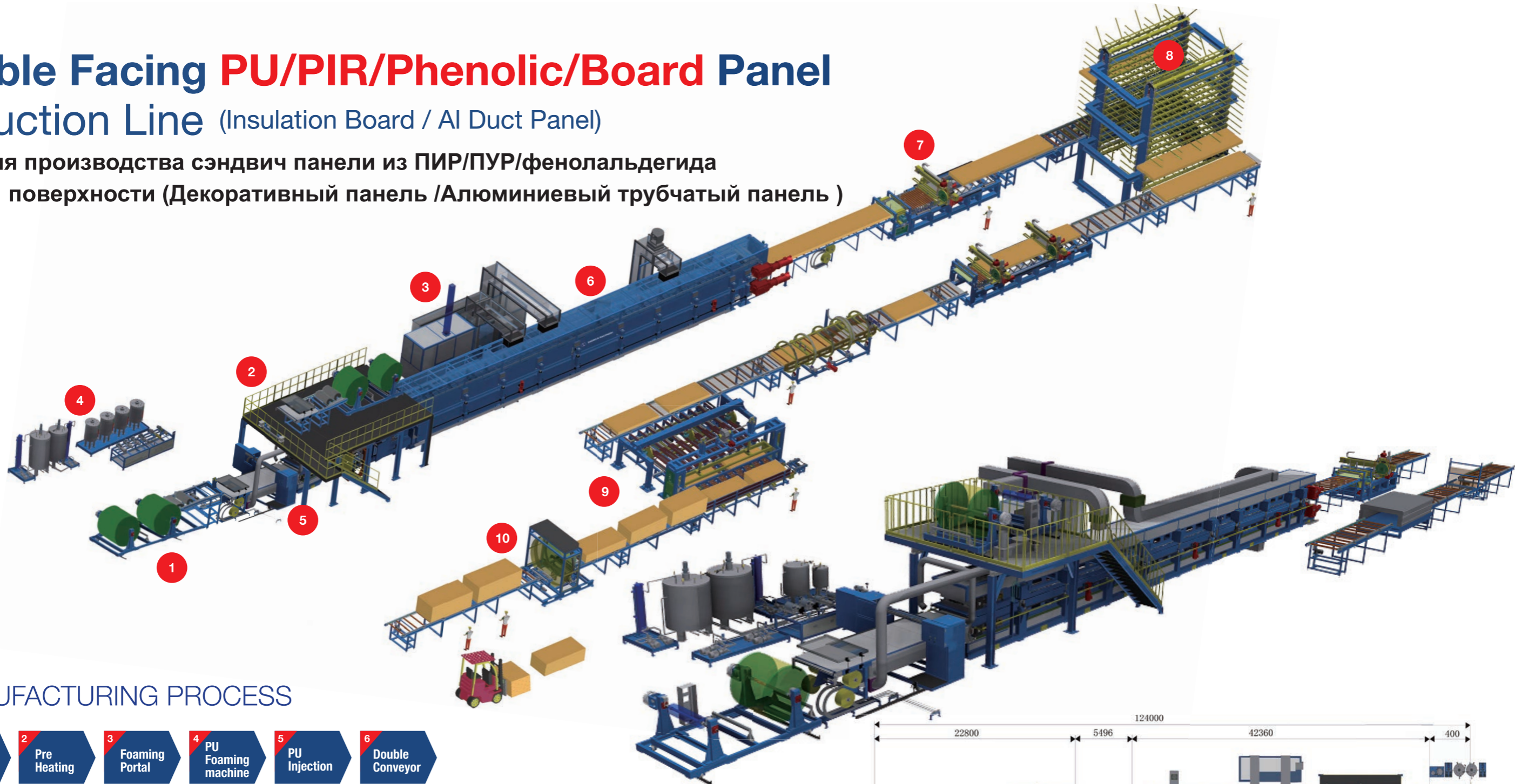

MANUFACTURING PROCESS

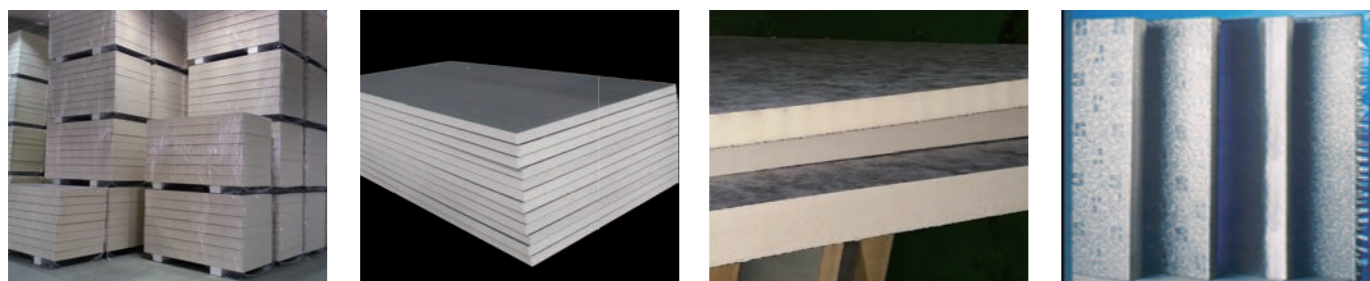
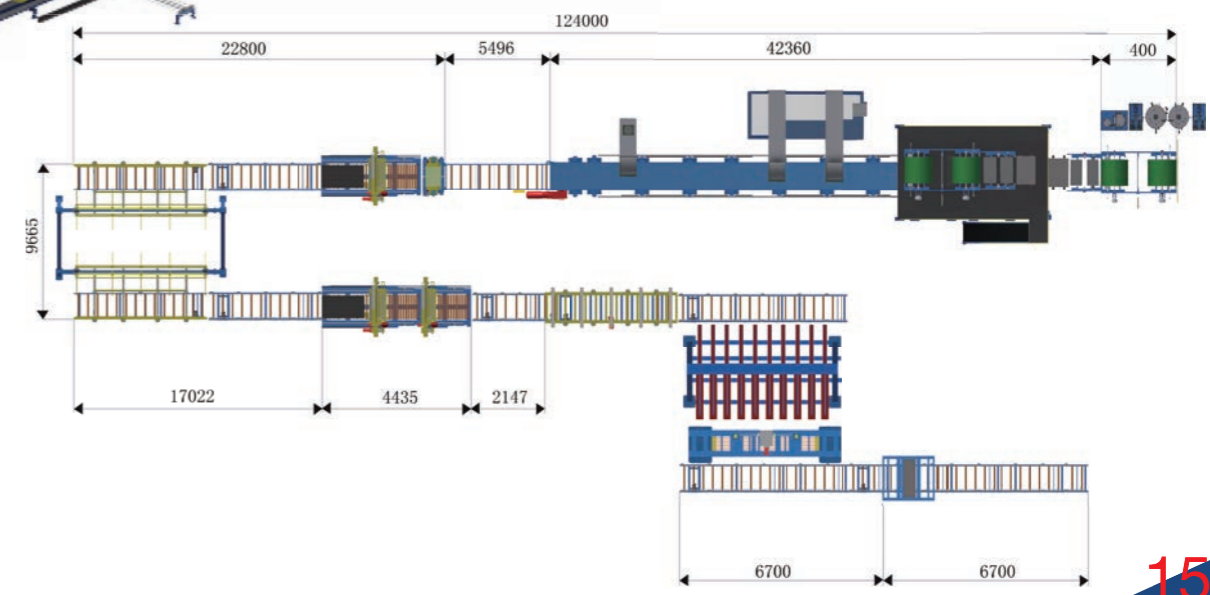

1 Uncoiler Разматватель

Uncoiler is drive type, and is installed two each at the upper part and the lower part separately. It is very difficult for the flexible facing such as paper, minerals hear non woven, aluminum foil differently on steel plate to entry into a double belt conveyor when it is untied from uncoiler. So, auto centering device(E.P.C.) and tension control device should be installed to the uncoiler. Facing materials : Soda kraft paper, Aluminium foil, mineral shear non oven, etc.

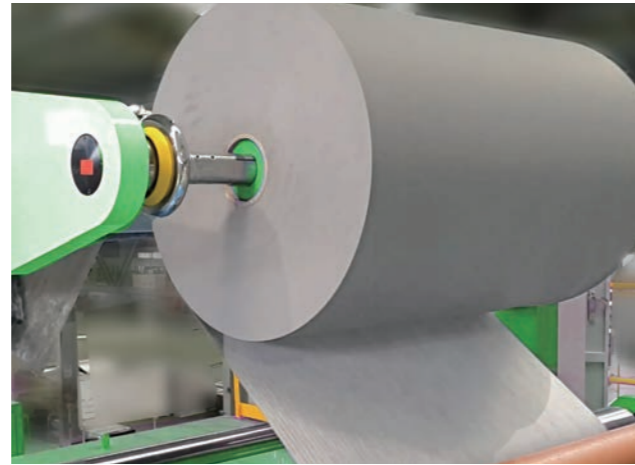

2 Pre Heating Подогревание

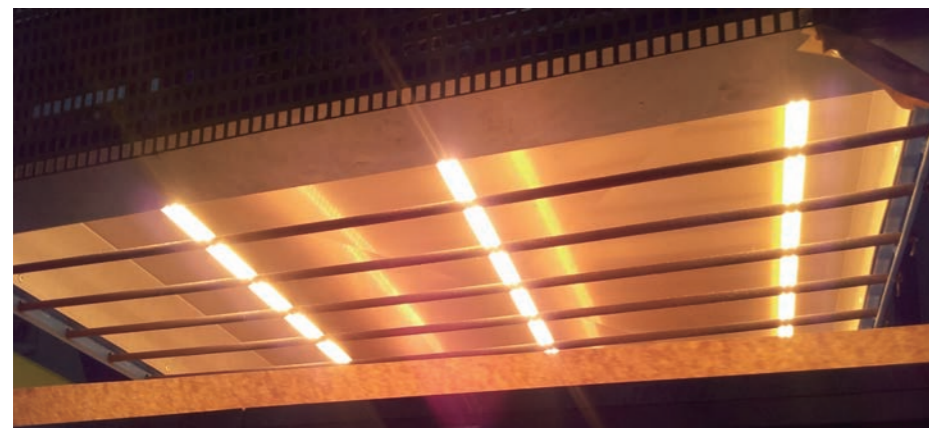

3 PU Foaming Machine

Система заливания полиуретана

It is designed for mixing and metering the raw material Polyol, Iso, Pentane, Additive and Catalysts.

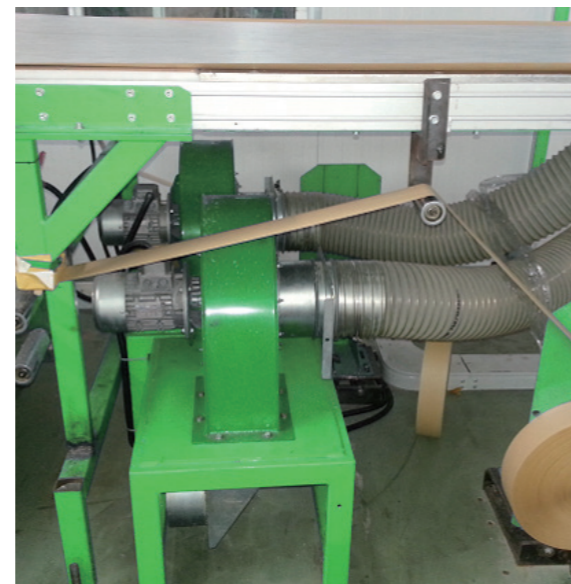

4 PU Injection Вливание полиуретана

PU material is outputted from outlet pipe of the mixing head onto the lower facing layer while moving crosswise along the Foaming Portal (Coating Gantry)



5 Double Conveyor & heating

Гусеничный пресс /нагревание

The double belt is designed to contain the uprising pressure during the foam reactive process by the action of a screw jack ensure the required flexible facing panel thickness.

The double belt conveyor conveys a continuous panel from PU foaming portal to the cutter while containing upper, lower and lateral uprising pressure while keeping up the uniform thickness and facing of the finished panel.



6 Cutting Резка

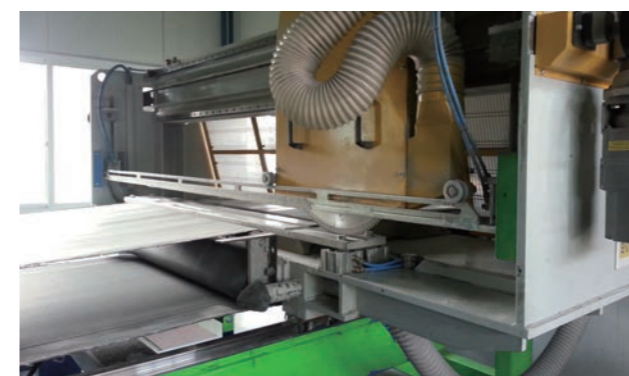

Discontinuous Panel Production Line

Cold Room Panel Production Line (2+2 System)

Прерывная линия для производства сэндвич панели из полиуретана (для холодильника 2+2)

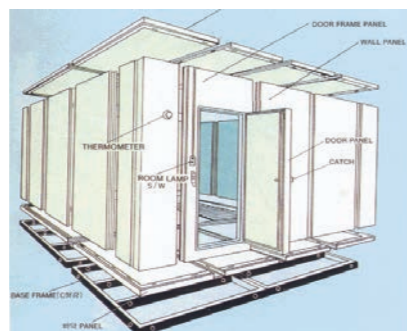
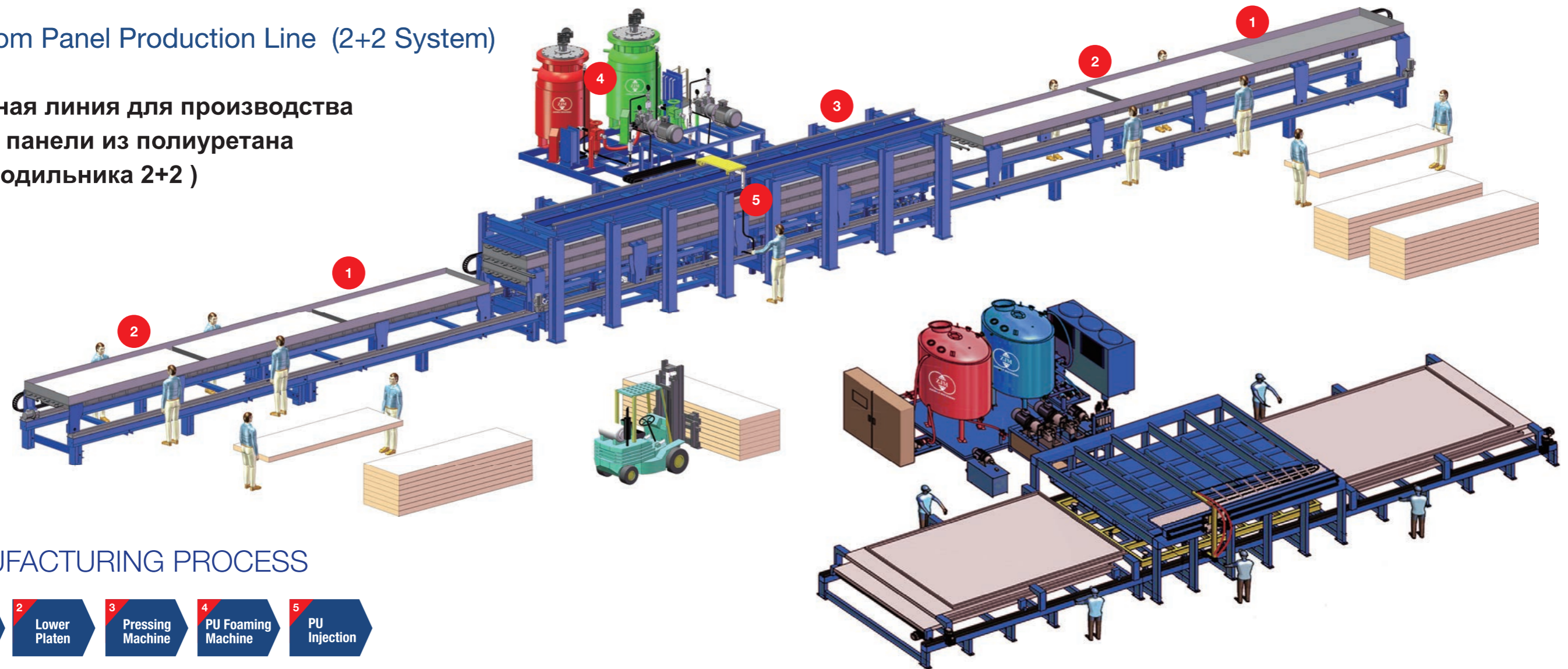

Working Platens

One fixed top plate and 4 movable platens for simultaneous and alternating loading/unloading.

Frame & Structure

Welded beam structure composed by steel beams.
Every support point (for the beams, for the pistons, for the plates), are worked by CNC tool-machine to grant the parallelism during the assembling of the structure.
Double rack and pinion system on the length and on the width to grant the perfect movement of the platens.

Heating Plate

Assembled solid steel plates predisposed for heating plant which uses water as heating liquid.

1-2 Upper and Lower Platen Верхняя и нижняя пресс-платина



3 Pressing Machine Прессование

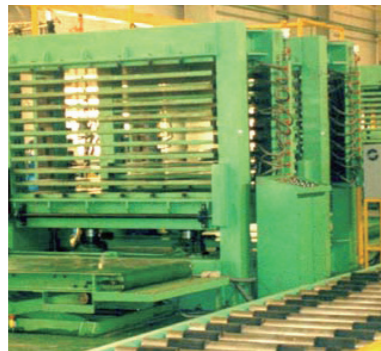

4 PU Foaming Machine Заливание полиуретана

Each metering unit is separately fitted for the Polyol and Isocyanate, and consists of an axial piston pump, coupling, flanged A.C motor, pump support and safety valve.
The pump output can be adjusted infinitely by hand-wheel and scales fitted to the pump housing.

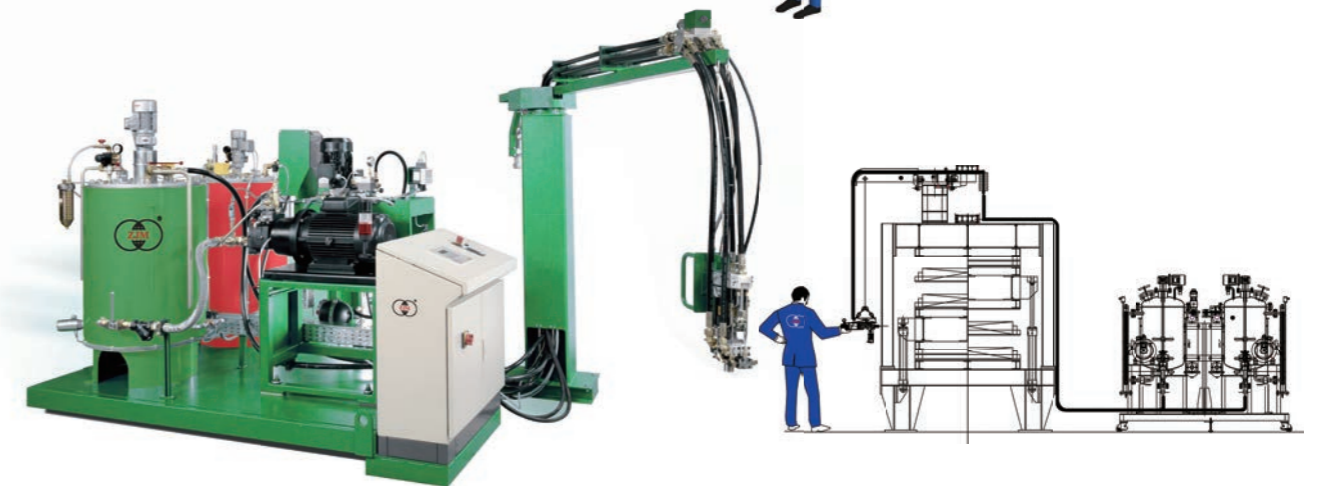
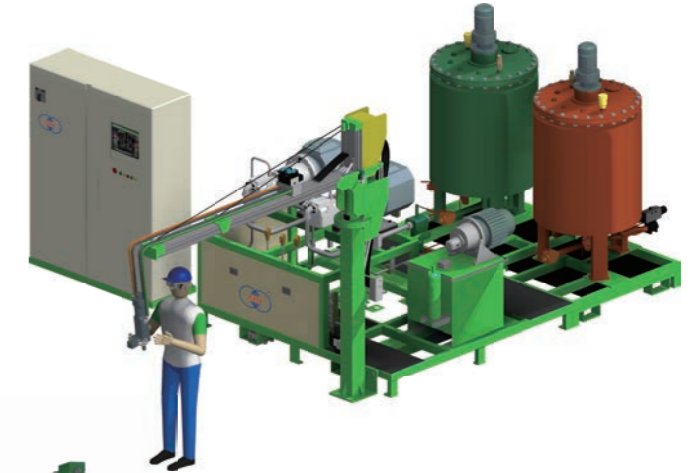

5 2+2 press layout Схема расположения прессования

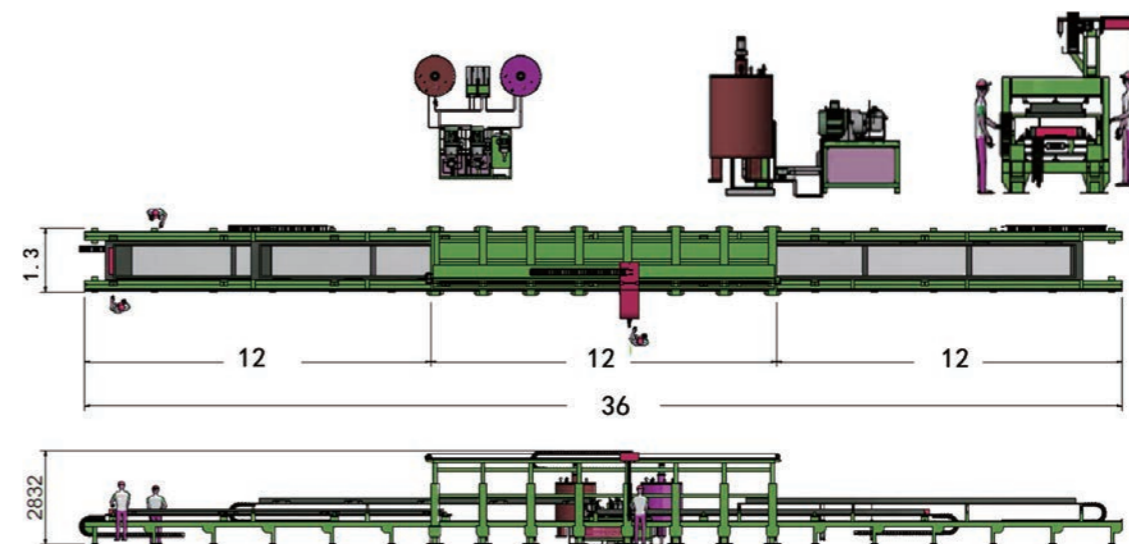

PU Sandwich Panels

Сэндвич панель из полиуретана

BOLTLESS WALL PANEL Скрытый стеновой панель

JOINT

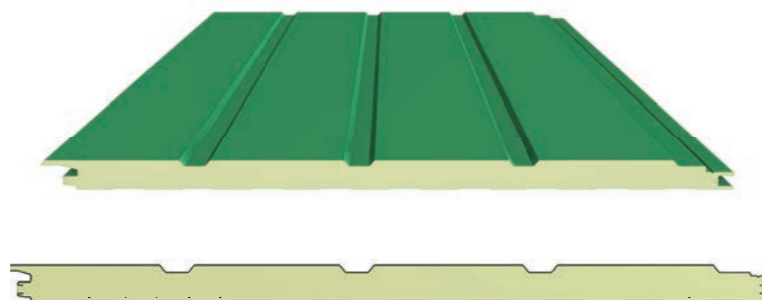
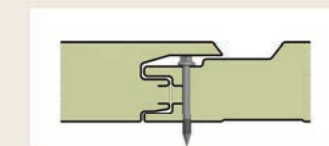

JOINT

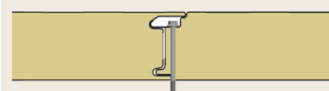

WALL(SS, COLD ROOM) PANEL Стена и холодильник

JOINT

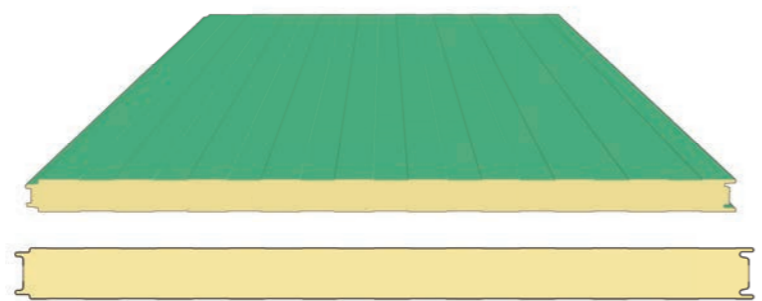
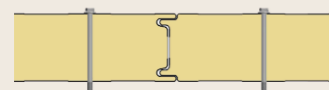

JOINT

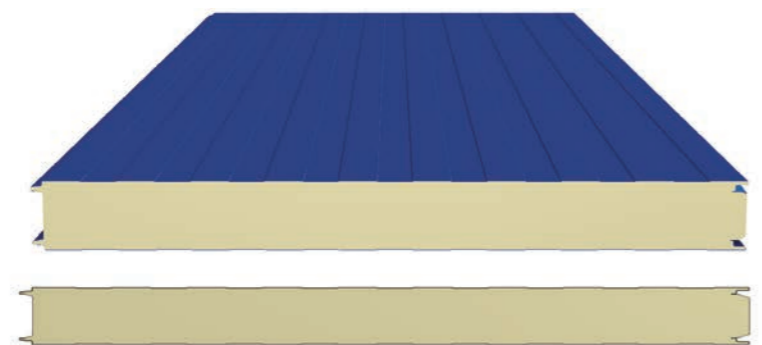
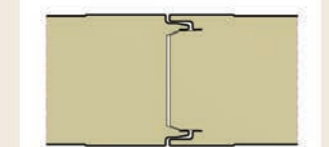

ROOF PANEL Крыша из полиуретана

JOINT

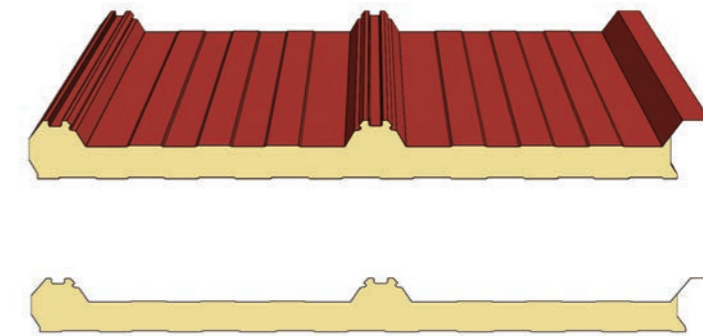
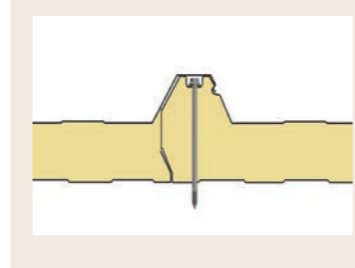

JOINT

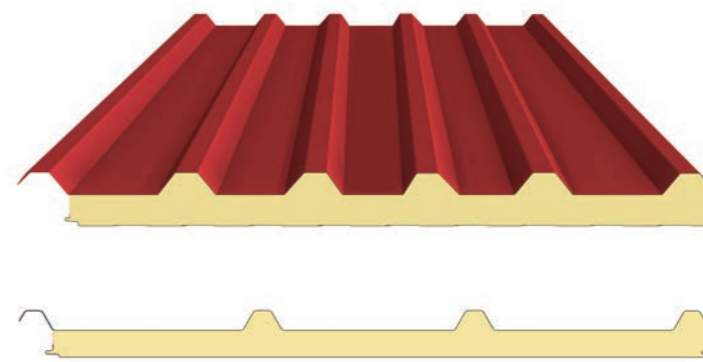
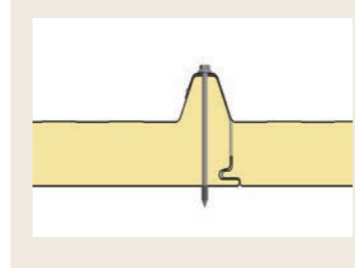

JOINT

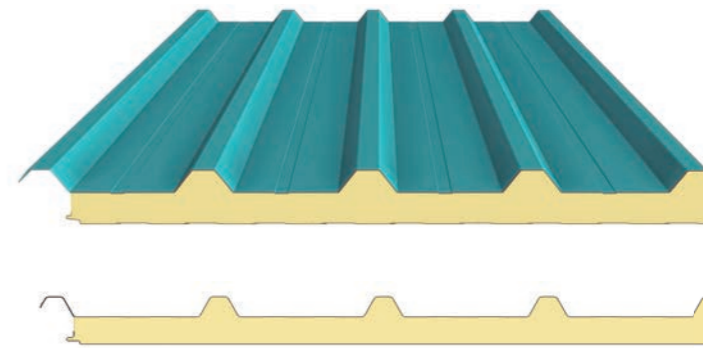
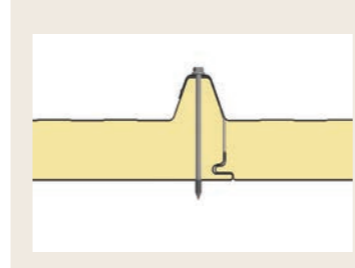

JOINT

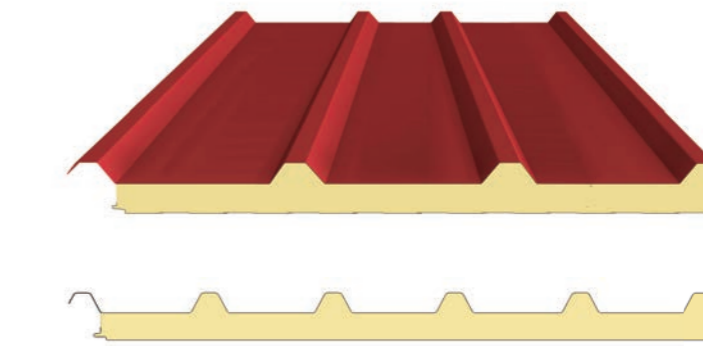
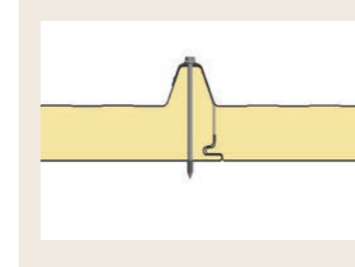

MINERAL WOOL SS PANEL Z-LOCK стена из минваты

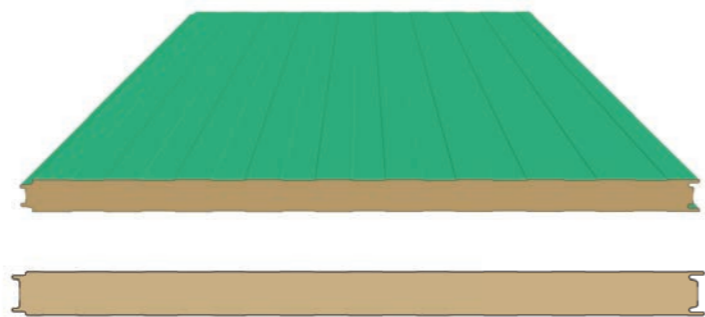
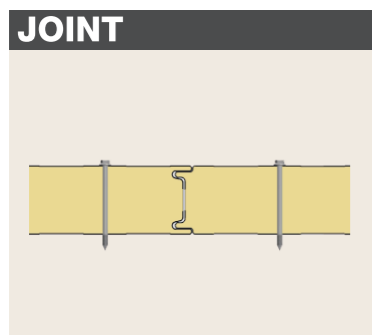

MINERAL WOOL+PU PANEL

Сэндвич панель из минваты с краем из полиуретана

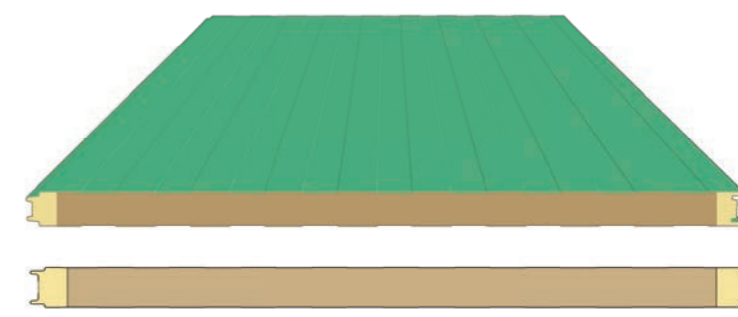
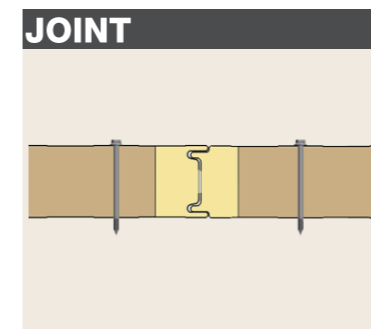

MINERAL WOOL BOLTLESS PANEL Скрытый стена из минваты

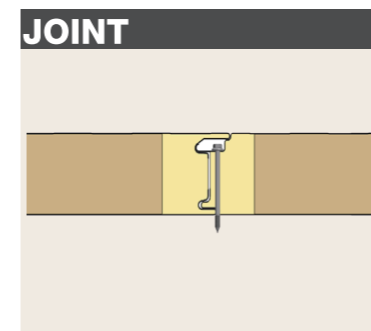
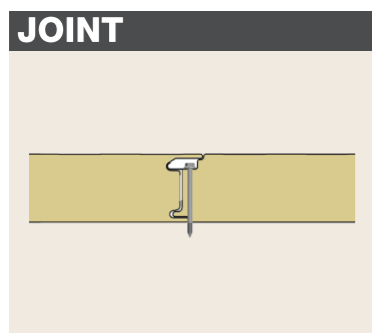

MINERAL WOOL ROOF PANEL Крыша из минваты

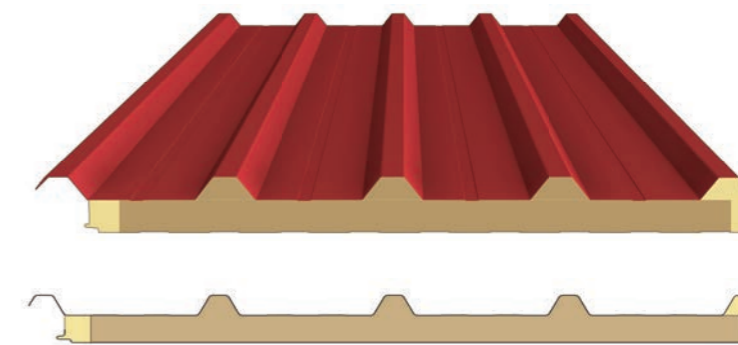
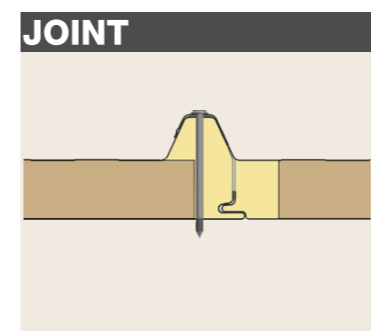
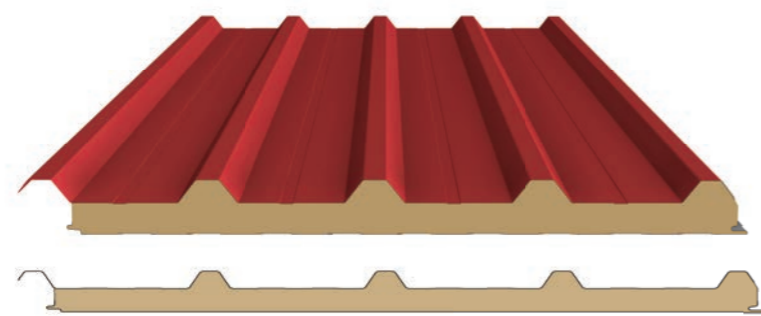
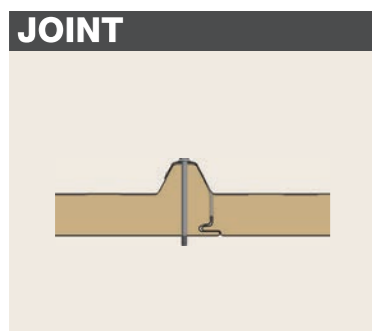

HOOK ROOF PANEL

Крюковая крыша

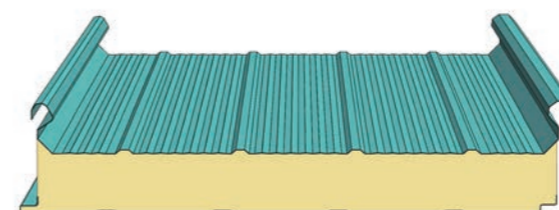

BRICK PANEL

Кирпичный панель



PU BOARD PANEL

Панель из полиуретана с бумажной поверхности



PU AL DUCT PANEL

Панель из полиуретана с алюминиевой поверхности

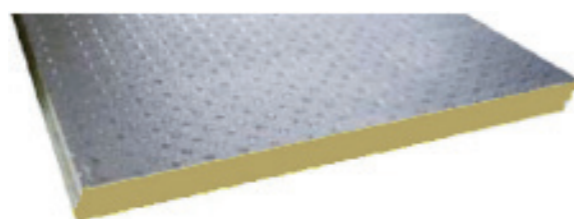

All Kinds of Roll Forming Machines

Профилегибочное оборудование для производства разных профилей

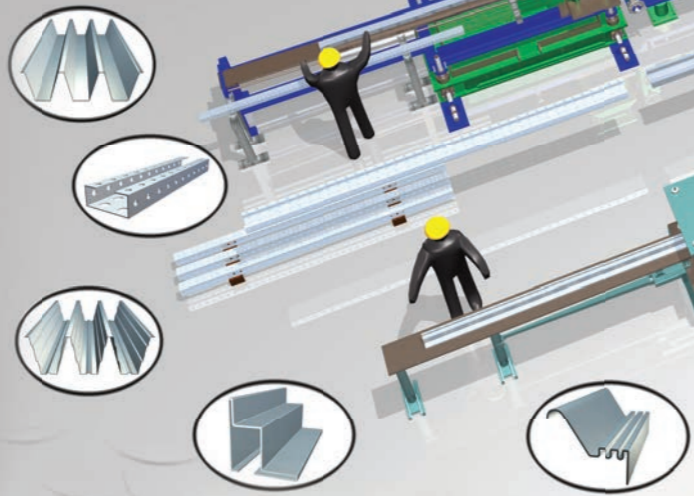
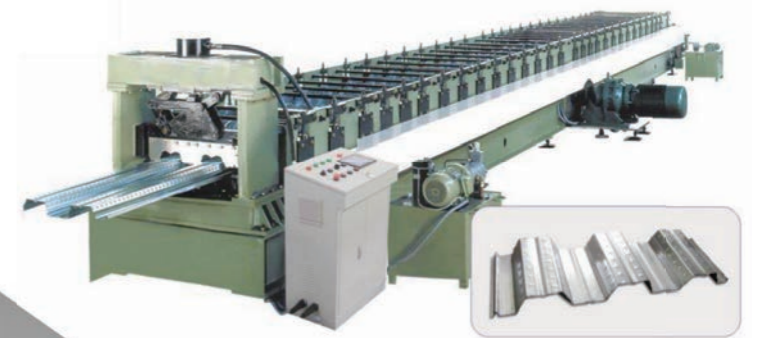
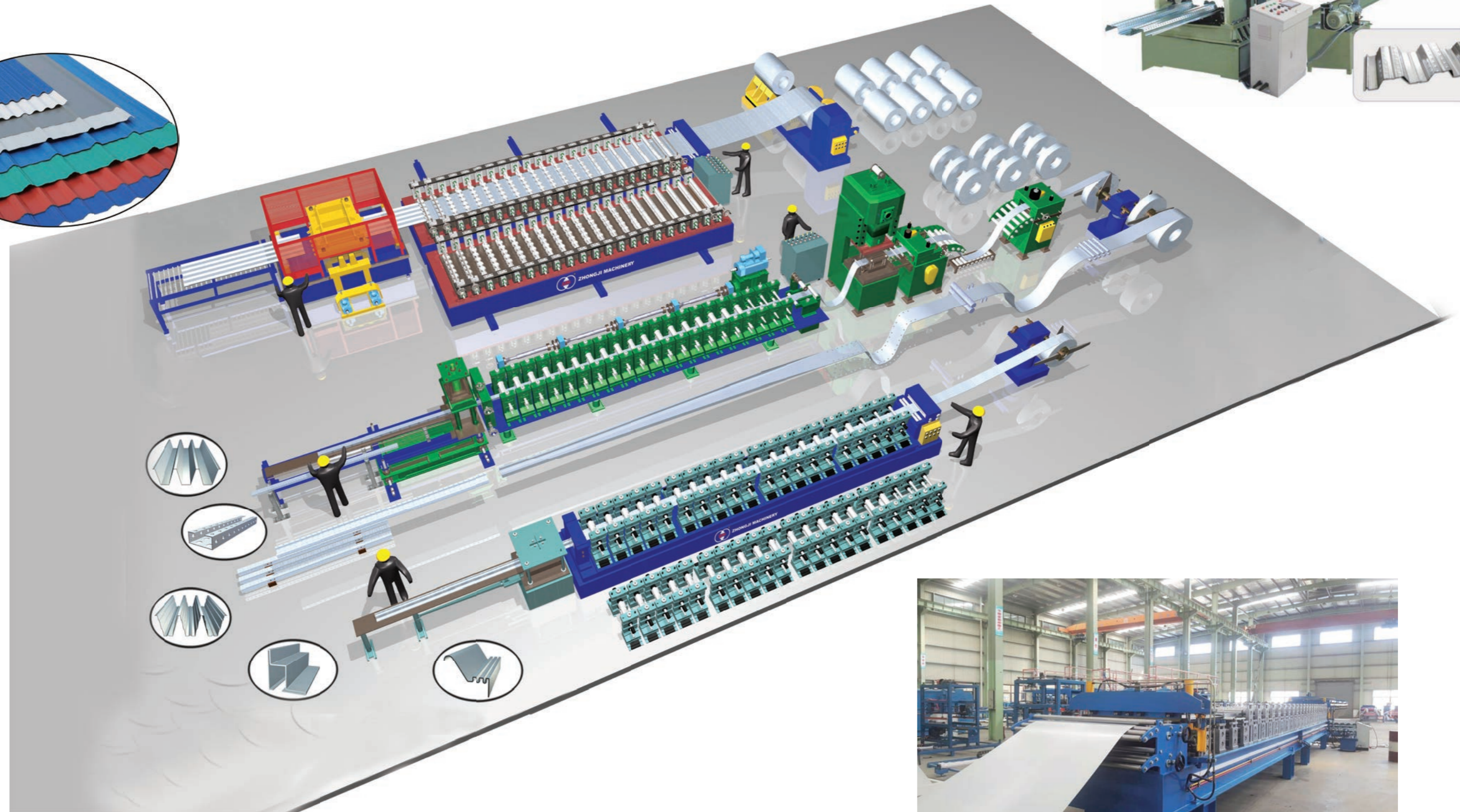
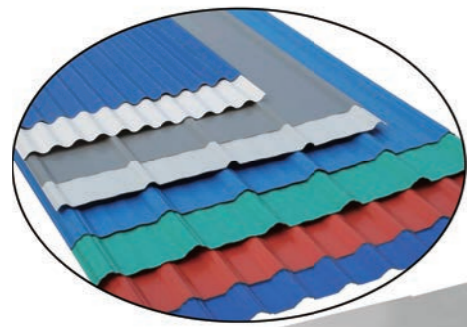

High Speed Slitting Line - Automatic Steel Sheet Slitting Machine

Продольная резка с быстрой скорости

Slitting Line, called slitting machine or longitudinal cutting line, is used to uncoiling, slitting, recoiling the steel rolls into demand width steels. It can be applied to process the cold or hot rolled steel coil, silicon steel coils, tinplate coils, stainless steel and color coated steels.

1.Function: it is used to the longitudinal cutting for the steel coils and rewinding the slit strips into coils.

2.Advantages: convenient to operate, high cutting precision and utilization factor of the material, adopts the infinitive speed.

3.Structure: compose of decoiler, feeding device, slitting machine, recoiler (Rewinding) machine.

4.Material can be processed: galvanized steel, stainless steel tinplate, silicon steel, copper and aluminum, etc.

5.Industries can be applied to: steel factory, transformer, electrical motor, electrical equipment, car, building materials, door, packaging industries.



Technical Data

Mode	Thickness(mm)	Coil width(mm)	No. of slitting	Dimensional tolerance (± mm/m)	Line speed(m/min)	Coil weight(t)
BZHS-1X850	0.3-2	150-850	10-30	0.03	0-120	5、10
BZHS-2X850	0.3-2	300-850	10-30	0.03	0-120	5、10
BZHS-2X1300	0.3-2	500-1300	10-30	0.03	0-120	10、15
BZHS-2X1600	0.3-2	600-1600	10-30	0.03	0-120	15、20
BZHS-3X1300	0.4-3	500-1300	8-30	0.03	0-120	10、15
BZHS-3X1600	0.4-3	600-1600	8-30	0.03	0-120	15、20
BZHS-4X1300	0.5-4	500-1300	6-25	0.05	0-120	10、15
BZHS-4X1600	0.5-4	600-1600	6-25	0.05	0-120	15、20
BZHS-6X1600	1-6	600-1600	5-20	0.05	0-100	15、20、25
BZHS-6X2000	1-6	800-2000	5-20	0.05	0-100	15、20、25

Cut to Length Line Поперечная резка



This production line is to cut cold rolled steel coils, stainless steel coils, aluminum coils into different sizes of sheet materials.

Standard facilities are entry coil car, un-coiler machine, press and pinch device, straightening machine, transition bridge I and II, side guide device, servo straightening machine, cutter machine, transportation table and pneumatic stacker, X-shaped table, exit car, hydraulic system and electrical system.

This production line adopts the high precision hydraulic elements and the fix position serving system to gauge the length. The whole line is designed with high automation, high straightening quality and cutting precision, high production efficiency and stable performance so as to easy to maintain and operate. The ling speed reaches to 0-80m/min.

EPS/EPP Machines

Линия для производства EPS/EPP

